

# Finial F3

Front/ Side View:

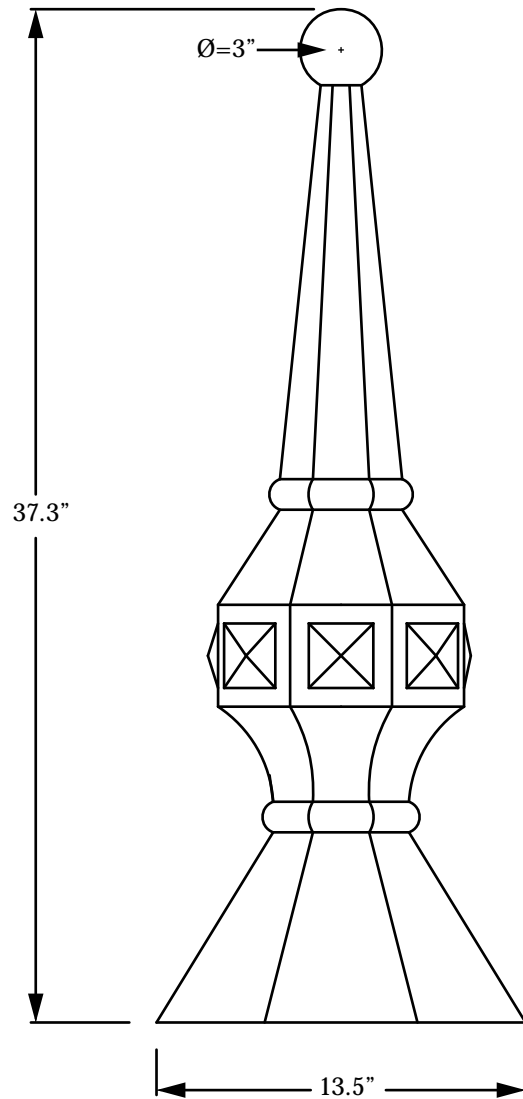

Isometric View:

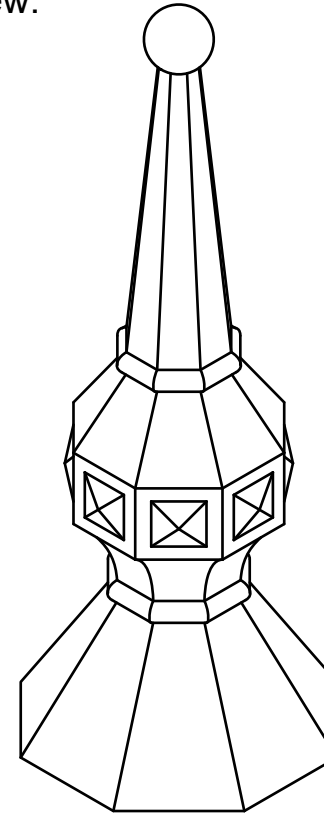

**MATERIAL**

- Aluminum Kynar .032 or \_\_\_\_\_  Color \_\_\_\_\_
- Galvanized G-90 24 Gauge
- Stainless Steel Type 304
- Painted Steel Kynar 24/26Gauge  Color \_\_\_\_\_
- Copper 16/20 oz or \_\_\_\_\_
- Patina 3000 16/20 oz \_\_\_\_\_
- Brown Copper 16/20 oz \_\_\_\_\_  Light  Dark
- SMS Stainless 24G \_\_\_\_\_
- Zinc \_\_\_\_\_

**\*Custom Sizing Available Call for Pricing\***

**CUSTOMER APPROVAL**

Approved for Fabrication

Authorized Customer Signature \_\_\_\_\_

Job Address:

PO #:

Date Ordered:

Order taken by:



**CHICAGO METAL SUPPLY**  
and fabrication, inc.

*FOR A TIMELESS LOOK™*

4940 W Grand ave. Phone: 773-227-6200

Chicago IL 60639 Fax: 773-227-1700

e-mail: info@chicagometalsupply.com

Due Date:

Job #:

Estimate #: