

Finial F16

Front/ Side View:

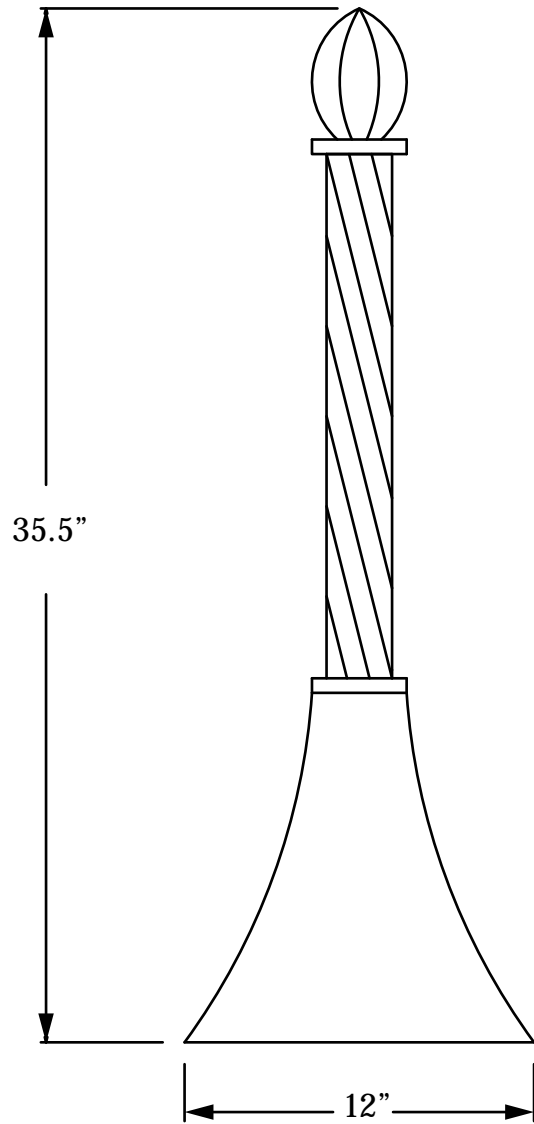

Isometric View:

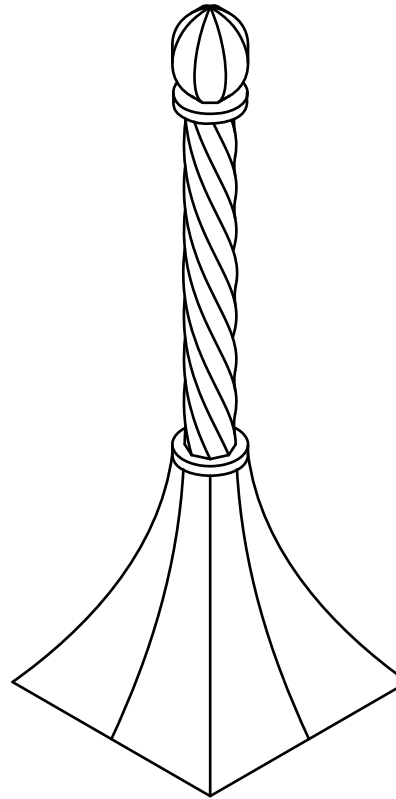

MATERIAL

- Aluminum Kynar .032 or _____ Color _____
- Galvanized G-90 24 Gauge
- Stainless Steel Type 304
- Painted Steel Kynar 24/26Gauge Color _____
- Copper 16/20 oz or _____
- Patina 3000 16/20 oz _____
- Brown Copper 16/20 oz _____ Light Dark
- SMS Stainless 24G _____
- Zinc _____

Custom Sizing Available Call for Pricing

CUSTOMER APPROVAL

Approved for Fabrication

Authorized Customer Signature _____

Job Address:

PO #:

Date Ordered:

Order taken by:



CHICAGO METAL SUPPLY
and fabrication, inc.

FOR A TIMELESS LOOK™

4940 W Grand ave. Phone: 773-227-6200

Chicago IL 60639 Fax: 773-227-1700

e-mail: info@chicagometalsupply.com

Due Date:

Job #:

Estimate #: